

Total solder points: 18

Difficulty level: *beginner* 1  2  3  4  5  *advanced*

## UNIVERSAL POWER SUPPLY 5 - 14DC / 1A

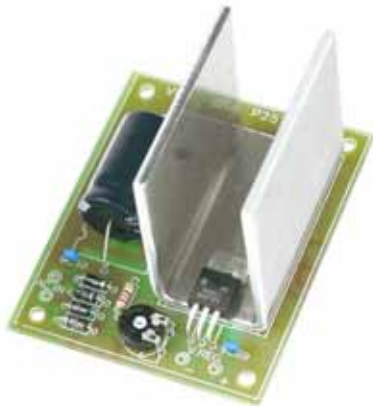

# *K2570*

The easy way to power your projects.

## Features

Suits all Velleman kits requiring a regulated power supply between 5 and 12VDC, and no more than 1A.

## Specifications :

- Input voltage: 7-16VDC / 1A
- Output voltage: 5-14VDC, regulated
- Output current: max. 1A
- Power limitation and thermal overload protection
- Max. dissipation: 7W
- PCB dimensions: 77 x 61mm (3.0" x 2.4")

## Can be combined with :

<b>K1771</b>	FM - oscillator	<b>K2656</b>	Universal crystal timebase
<b>K1803</b>	Universal mono pre - amplifier	<b>K3400</b>	Dual electronic dice
<b>K2032</b>	Digital panel meter	<b>K4601</b>	Audio / video tv modulator
<b>K2572</b>	Universal stereo pre-amplifier	<b>K4900</b>	Telephone amplifier
<b>K2573</b>	Stereo RIAA pre - amplifier	<b>K6400</b>	Code lock
<b>K2579</b>	Universal start / stop timer	<b>K8015</b>	Multifunction relay switch
<b>K2651</b>	LCD panel meter	<b>VM114</b>	7W mono audio amplifier
<b>K2655</b>	Electronic watchdog		

### 1. Assembly (Skipping this can lead to troubles ! )

Ok, so we have your attention. These hints will help you to make this project successful. Read them carefully.

#### 1.1 Make sure you have the right tools:

- A good quality soldering iron (25-40W) with a small tip.
- Wipe it often on a wet sponge or cloth, to keep it clean; then apply solder to the tip, to give it a wet look. This is called 'thinning' and will protect the tip, and enables you to make good connections. When solder rolls off the tip, it needs cleaning.
- Thin raisin-core solder. Do not use any flux or grease.
- A diagonal cutter to trim excess wires. To avoid injury when cutting excess leads, hold the lead so they cannot fly towards the eyes.
- Needle nose pliers, for bending leads, or to hold components in place.
- Small blade and Phillips screwdrivers. A basic range is fine.

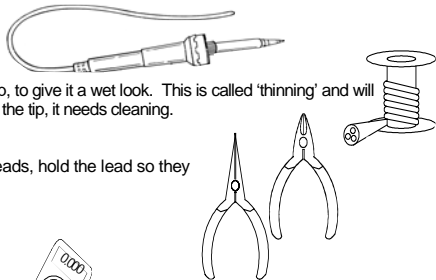

**For some projects, a basic multi-meter is required, or might be handy**

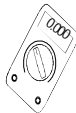

#### 1.2 Assembly Hints :

- ⇒ Make sure the skill level matches your experience, to avoid disappointments.
  - ⇒ Follow the instructions carefully. Read and understand the entire step before you perform each operation.
  - ⇒ Perform the assembly in the correct order as stated in this manual
  - ⇒ Position all parts on the PCB (Printed Circuit Board) as shown on the drawings.
  - ⇒ Values on the circuit diagram are subject to changes.
  - ⇒ Values in this assembly guide are correct\*
  - ⇒ Use the check-boxes to mark your progress.
  - ⇒ Please read the included information on safety and customer service
- \* Typographical inaccuracies excluded. Always look for possible last minute manual updates, indicated as 'NOTE' on a separate leaflet.

### 1.3 Soldering Hints :

1- Mount the component against the PCB surface and carefully solder the leads

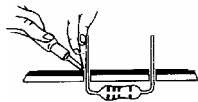

2- Make sure the solder joints are cone-shaped and shiny

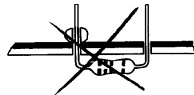
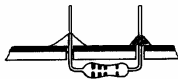

3- Trim excess leads as close as possible to the solder joint

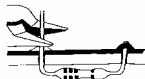

**AXIAL COMPONENTS ARE TAPED IN THE CORRECT MOUNTING SEQUENCE !**

**REMOVE THEM FROM THE TAPE ONE AT A TIME !**

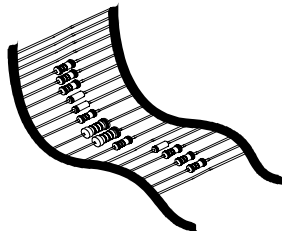

 You will find the colour code for the resistances and the LEDs in the HALG (general manual) and on our website: <http://www.velleman.be/common/service.aspx>

### 1. Diodes. Watch the polarity !

- D1 : 1N4007
- D2 : 1N4007
- D3 : 1N4007
- D4 : 1N4007

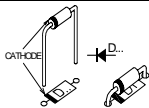

### 2. Resistor

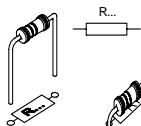

- R1 : 270 (2 - 7 - 1 - B)

### 3. Capacitors

- C1 : 100nF (104)
- C3 : 100nF (104)

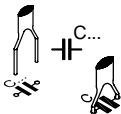

### 4. Trim potentiometer

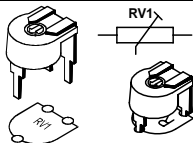

- RV1 : 470 ohm

### 5. Electrolytic Capacitor. Watch the polarity !

- C2 : 2200 $\mu$ F

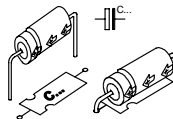

### 6. Voltage regulator

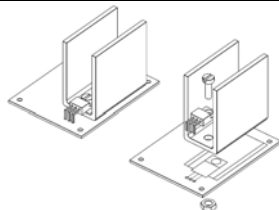

- VR : UA7805

- Place the heatsink and the regulator on the PCB.
- ☞ Ensure that the hole of the heatsink and the one of the regulator correspond to the hole in the PCB.
- ☞ Use heatsink compound to ensure good heat dissipation.
- Fix the two components with an M3 bolt and nut.
- Now, the regulator may be soldered.

## 7. Use

To use the circuit without problem, take into account the power dissipation in the regulator.

☞ The transformer voltage must always be 2V higher than the maximum desired output voltage.

If, for instance, you need an output voltage of 12V, then you need to fit a transformer of 14V.

If, as an output voltage you only need 6V, use a transformer having 8V and not 14V, because with an 8V transformer the dissipation in the regulator will be of approximately 5W when drawing a current of 1A. With a 14V transformer, the dissipation will be higher than 10W. In the second case the regulator will die in a few minutes.

The transformer should be connected to the points "AC IN" and the output voltage is connected at points + and - (Vreg).

## 8. PCB

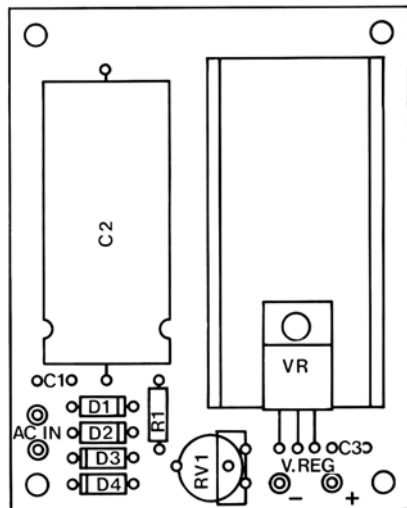

9. DIAGRAM

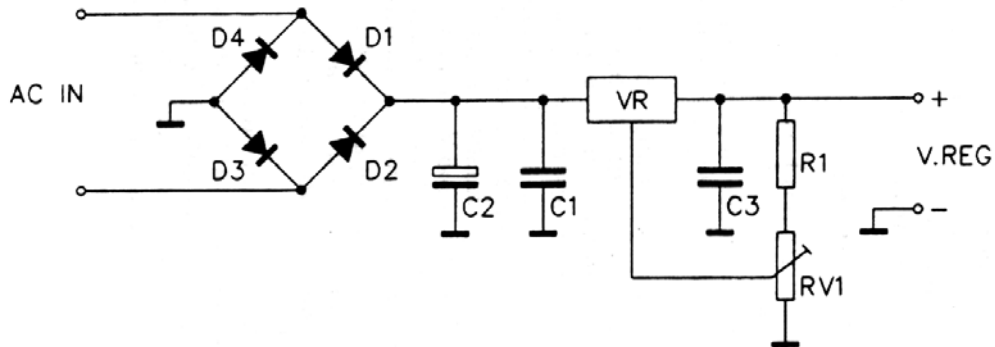



Modifications and typographical errors reserved  
© Velleman Components nv.  
H2570IP - 2004 - ED1

