

Total solder points: 79

Difficulty level: *beginner* 1 2 3 4 5 *advanced*

GUITAR PREAMPLIFIER WITH HEADPHONE OUTPUT



K4102

*Practice the guitar without
disturbing others.*

Features:

An electric guitar cannot be connected to just any amplifier or audio installation. This preamplifier has been designed for this purpose and provides you with a headphone output, allowing you to practice without disturbing others. Moreover, it is fitted with a special device for tone adjustment, allowing anyone to create their personal sound.

- sound adjustment
- adjustable input sensitivity
- low noise
- housing included

Specifications:

- Headphones output: max. 2 x 50mW / 32ohm
- Power supply: 9V battery (not incl.)
- Dimensions: 70 x 30 x 105mm (2.8" x 1.2" x 4.1")

1. Assembly (Skipping this can lead to troubles !)

Ok, so we have your attention. These hints will help you to make this project successful. Read them carefully.

1.1 Make sure you have the right tools:

- A good quality soldering iron (25-40W) with a small tip.
- Wipe it often on a wet sponge or cloth, to keep it clean; then apply solder to the tip, to give it a wet look. This is called 'thinning' and will protect the tip, and enables you to make good connections. When solder rolls off the tip, it needs cleaning.
- Thin raisin-core solder. Do not use any flux or grease.
- A diagonal cutter to trim excess wires. To avoid injury when cutting excess leads, hold the lead so they cannot fly towards the eyes.
- Needle nose pliers, for bending leads, or to hold components in place.
- Small blade and Phillips screwdrivers. A basic range is fine.

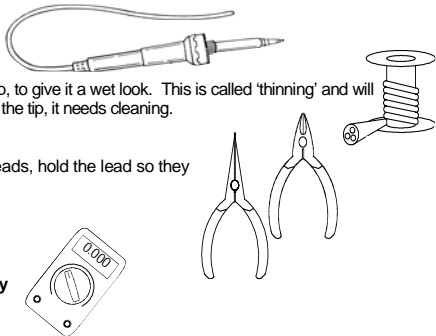

For some projects, a basic multi-meter is required, or might be handy

1.2 Assembly Hints :

- ⇒ Make sure the skill level matches your experience, to avoid disappointments.
- ⇒ Follow the instructions carefully. Read and understand the entire step before you perform each operation.
- ⇒ Perform the assembly in the correct order as stated in this manual
- ⇒ Position all parts on the PCB (Printed Circuit Board) as shown on the drawings.
- ⇒ Values on the circuit diagram are subject to changes.
- ⇒ Values in this assembly guide are correct*
- ⇒ Use the check-boxes to mark your progress.
- ⇒ Please read the included information on safety and customer service

* Typographical inaccuracies excluded. Always look for possible last minute manual updates, indicated as 'NOTE' on a separate leaflet.

1.3 Soldering Hints :

1- Mount the component against the PCB surface and carefully solder the leads

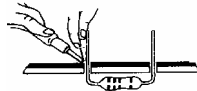

2- Make sure the solder joints are cone-shaped and shiny

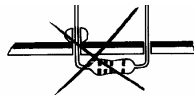
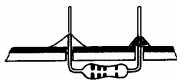

3- Trim excess leads as close as possible to the solder joint

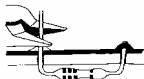

REMOVE THEM FROM THE TAPE ONE AT A TIME !

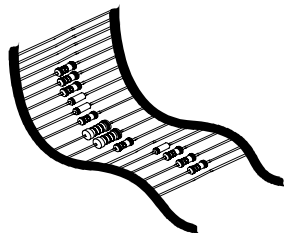

**AXIAL COMPONENTS ARE TAPED IN THE
CORRECT MOUNTING SEQUENCE !**



You will find the colour code for the resistances and the LEDs in the HALG (general manual) and on our website: <http://www.velleman.be/common/service.aspx>

1. Zenerdiode. Watch the polarity!

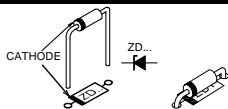

- ZD1 : 4V7

2. 1/4W Resistors

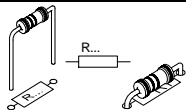

- R1 : 470K (4 - 7 - 4 - B)
- R2 : 470K (4 - 7 - 4 - B)
- R3 : 47K (4 - 7 - 3 - B)
- R4 : 10K (1 - 0 - 3 - B)
- R5 : 10K (1 - 0 - 3 - B)
- R6 : 10K (1 - 0 - 3 - B)
- R7 : 68 (6 - 8 - 0 - B)
- R8 : 68 (6 - 8 - 0 - B)
- R9 : 390 (3 - 9 - 1 - B)
- R10 : 2,2 (2 - 2 - B - B)
- R11 : 2,2 (2 - 2 - B - B)

3. Capacitors

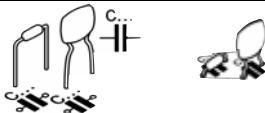

- C1 : 470pF (471)
- C2 : 10nF (103)
- C3 : 33nF (333)
- C4 : 33nF (333)
- C5 : 100nF (104)
- C6 : 100nF (104)
- C7 : 470nF (474)
- C8 : 470nF (474)
- C9 : 470nF (474)

4. IC socket. Watch the position of the notch!

- IC1 : 8p

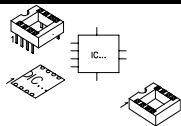

5. Resistor trimmers

- RV1 : 100K
- RV2 : 1K

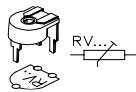

6. Switch

- SW1

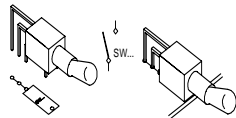

7. Electrolytic Capacitors

- C10 : 220µF
- C11 : 220µF
- C12 : 220µF

Watch the polarity!

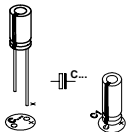

8. RCA connectors

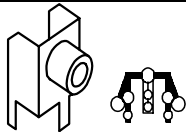

- J1 GUITAR IN
- J2 LINE OUT

9. Headphones connector

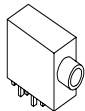

- J3 : 3,5mm stereo phone

10. LED

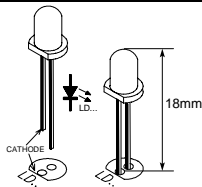

- LD1 : 3mm red

11. IC. Watch the position of the notch!

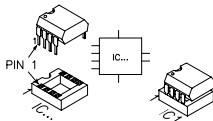

- IC1 : NE5532A

12. Battery snap

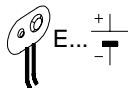

The connection leads are first plaited through the openings to reduce pulling. The red is connected to the "+" and the black to the "-".

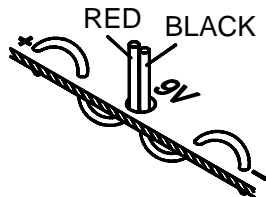

Fig 1.0

13. Assembly in the housing

- Attach the sticker showing the connections to the housing, fig 4.0.
- Mount three spacers to the bottom of the housing, together with a shakeproof washer and an M3 countersunk bolt, see figure 2.0

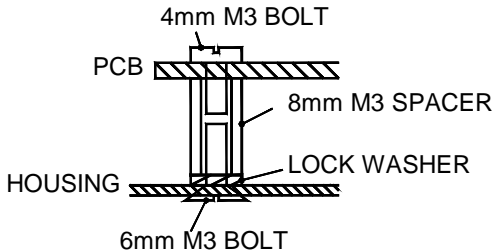

Fig 2.0

- Mount the PCB on the spacers using the three M3 bolts
- Click the shaft into the tone-control potentiometer and mount the knob on the shaft, fig 3.0
- After connection of the 9V battery (check the polarity), the cover of the housing can be clicked in place.

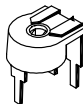
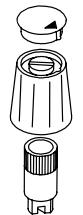
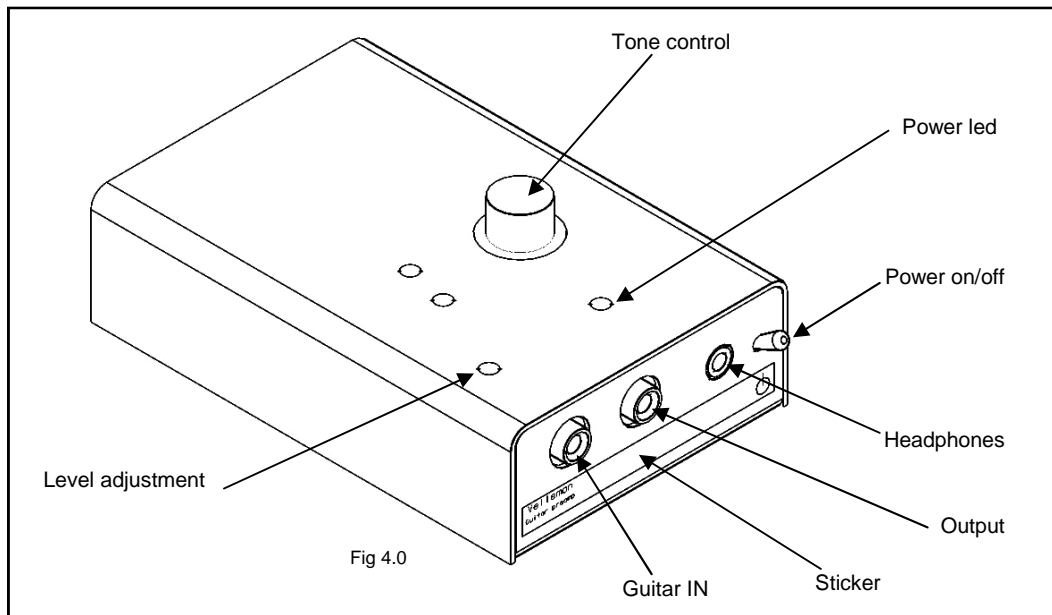

Fig 3.0



14. Test & use

- Connect a 9V battery and switch the equipment on. The LED should normally light up. This LED is also used as a "battery low" indication.
- Turn potentiometer RV1 to the middle of its adjustment range and connect a pair of headphones to the unit. A slight hum should be heard in the headphones when the central terminal of the input connector is touched. Turn the tone control RV2 clockwise and slight noise should be heard.
- The guitar can be connected to the input connector by using a suitable cable. The sensitivity can be controlled using "RV1".
- The output connector can be connected to the "TAPE IN" or "AUX" input of a stereo system. Be very careful with the volume knob so that you do not damage your expensive speakers.

15. Schematic diagram.

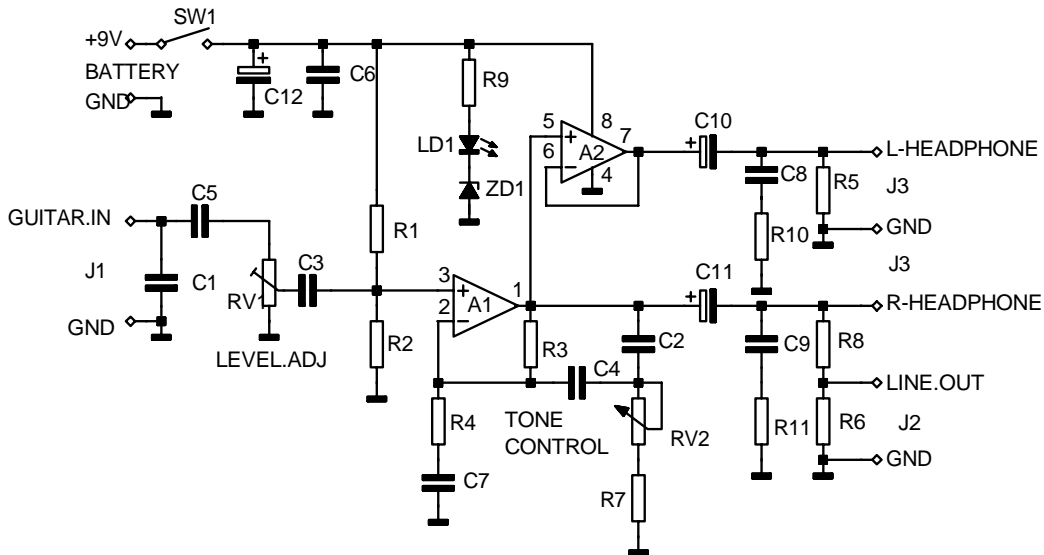

16. PCB

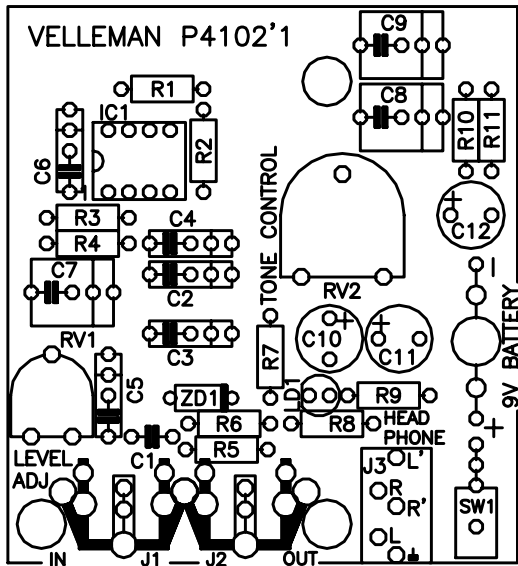



Modifications and typographical errors reserved
© Velleman Components nv.
H4102IP - 2004 - ED1

