

Total solder points: 24

Difficulty level: *beginner* 1 2 3 4 5 *advanced*

1 A POWER SUPPLY

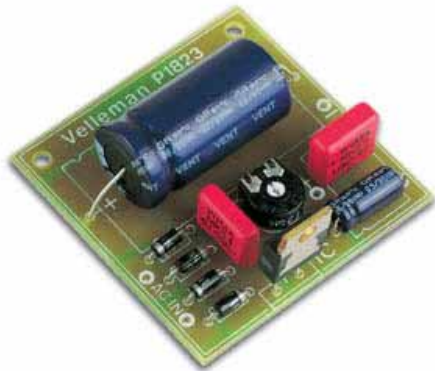

K1823

The easy way to power your projects.

Features

- ☑ Just add a suitable transformer (see table)
- ☑ Great to power your projects and save money on batteries
- ☑ Suitable as an adjustable power supply for experiments
- ☑ Control DC motors, low voltage light bulbs, ...

Specifications :

- Preset any voltage between 1.5 and 35V
- Very low ripple (80dB rejection)
- Short-circuit, thermal and overload protection
- Max input voltage : 28VAC or 40VDC
- Max dissipation : 15W (with heatsink)
- Dimensions : 52x52mm (2.1" x 2.1")

Choose the right transformer	
Max DC output voltage	Transformer rating
3..5V	9VAC / 15VA
5..8V	12VAC / 30VA
8..13V	15VAC / 30VA
13..15V	18VAC / 30VA
15..18V	22VAC / 30VA
18..22V	24VAC / 50VA
22..35V	28VAC / 50VA



1. Assembly (Skipping this can lead to troubles !)

Ok, so we have your attention. These hints will help you to make this project successful. Read them carefully.

1.1 Make sure you have the right tools:

- A good quality soldering iron (25-40W) with a small tip.
- Wipe it often on a wet sponge or cloth, to keep it clean; then apply solder to the tip, to give it a wet look. This is called 'thinning' and will protect the tip, and enables you to make good connections. When solder rolls off the tip, it needs cleaning.
- Thin raisin-core solder. Do not use any flux or grease.
- A diagonal cutter to trim excess wires. To avoid injury when cutting excess leads, hold the lead so they cannot fly towards the eyes.
- Needle nose pliers, for bending leads, or to hold components in place.
- Small blade and Phillips screwdrivers. A basic range is fine.

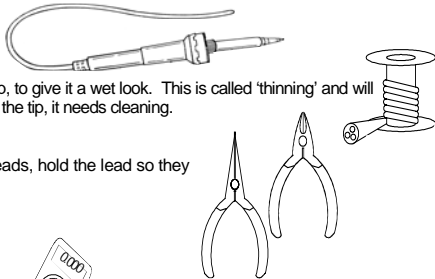

For some projects, a basic multi-meter is required, or might be handy

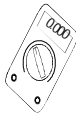

1.2 Assembly Hints :

- ⇒ Make sure the skill level matches your experience, to avoid disappointments.
 - ⇒ Follow the instructions carefully. Read and understand the entire step before you perform each operation.
 - ⇒ Perform the assembly in the correct order as stated in this manual
 - ⇒ Position all parts on the PCB (Printed Circuit Board) as shown on the drawings.
 - ⇒ Values on the circuit diagram are subject to changes.
 - ⇒ Values in this assembly guide are correct*
 - ⇒ Use the check-boxes to mark your progress.
 - ⇒ Please read the included information on safety and customer service
- * Typographical inaccuracies excluded. Always look for possible last minute manual updates, indicated as 'NOTE' on a separate leaflet.

1.3 Soldering Hints :

1- Mount the component against the PCB surface and carefully solder the leads

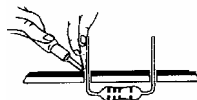

2- Make sure the solder joints are cone-shaped and shiny

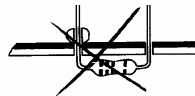
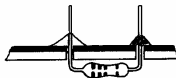

3- Trim excess leads as close as possible to the solder joint



AXIAL COMPONENTS ARE TAPED IN THE CORRECT MOUNTING SEQUENCE !

REMOVE THEM FROM THE TAPE ONE AT A TIME !

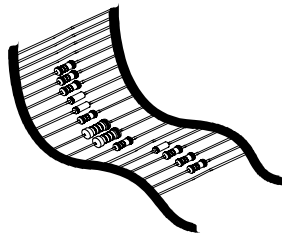

 You will find the colour code for the resistances and the LEDs in the HALG (general manual) and on our website: <http://www.velleman.be/common/service.aspx>

1. Diodes. Watch the polarity !

- D1 : 1N4007
- D2 : 1N4007
- D3 : 1N4007
- D4 : 1N4007

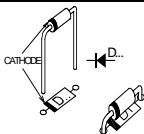

2. Resistor

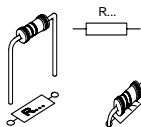

- R1 : 120 (1 - 2 - 1 - B)

3. Trim potentiometer

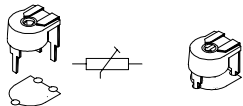

- R2 : 4K7

4. Electrolytic Capacitor. Watch the polarity !

- C2 : 10 μ F

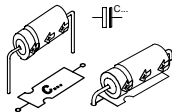

5. PCB tabs. (Optional)

- AC IN (x2)
- +
-

Ordernr. : printpz6

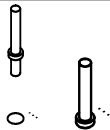

6. Capacitors.

- C1 : 0,1 μ F
- C3 : 1 μ F



7. Electrolytic Capacitor. Watch the polarity !

- C4 : 2200 μ F

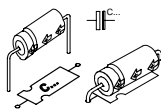

8. IC.

- IC : LM317

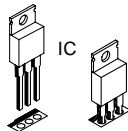

It has not to be cooled if used for small powers.
28VAC max. is allowed for the input voltage.

9. Connection example

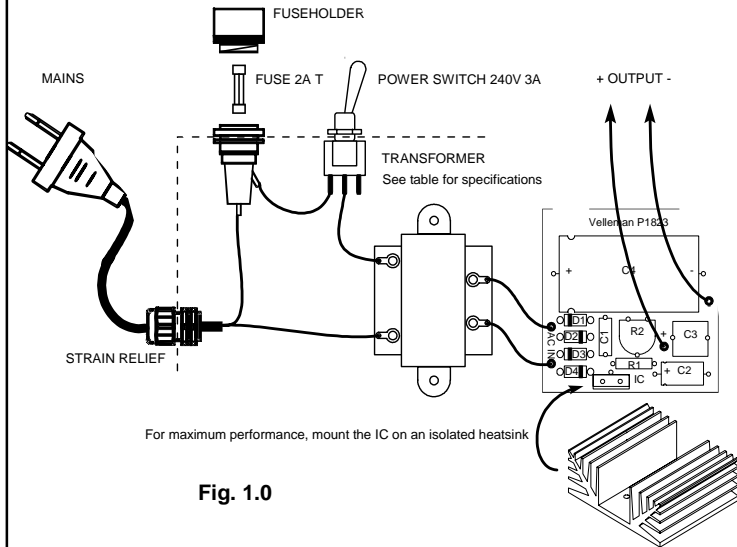

Fig. 1.0

Execute the connection as depicted in the figure. Connect the alternating voltage of a transformer with the 'AC IN' connections. Connect the output voltage with the '+' and '-' connections. Set the desired output voltage with trimmer R2. Mount IC1 on a suitable heatsink for applications requiring more power.

Be sure to provide sufficient electric insulation: fit an insulator and a plastic insulation ring between the IC and the heatsink because the metal side of the IC is electrically connected with the rest of the circuit.

Replace the trimmer with a potentiometer of the same rating if you want to use the circuit as a permanently adjustable power supply.

10. PCB layout.

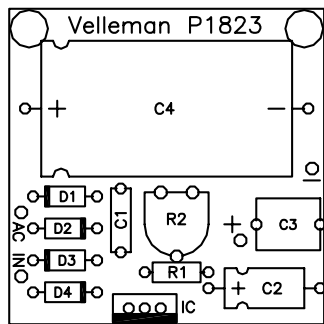

11. Diagram

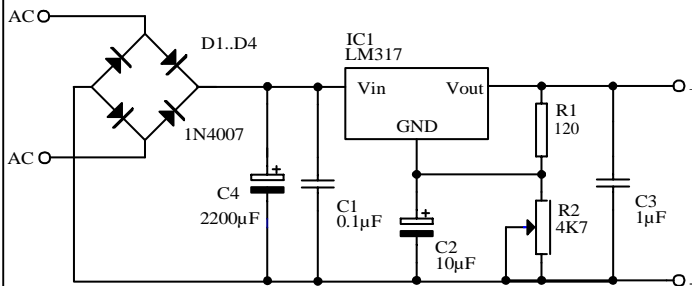



Modifications and typographical errors reserved
© Velleman Components nv.
H1823IP - 2004 - ED1

